

INDUSTRIAL DIESEL ENGINE

Kubota 03 Series (4-Cylinder)

V2403-CR-T-E5



Rated Power

50.0 kW @ 2700 rpm

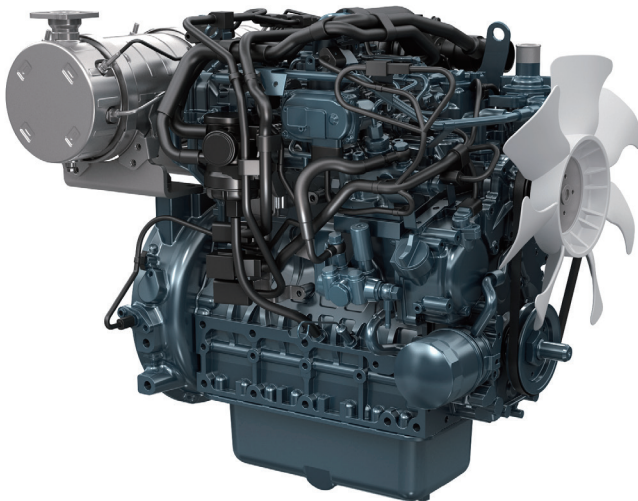

Photograph may show non-standard equipment.

Performance Curves

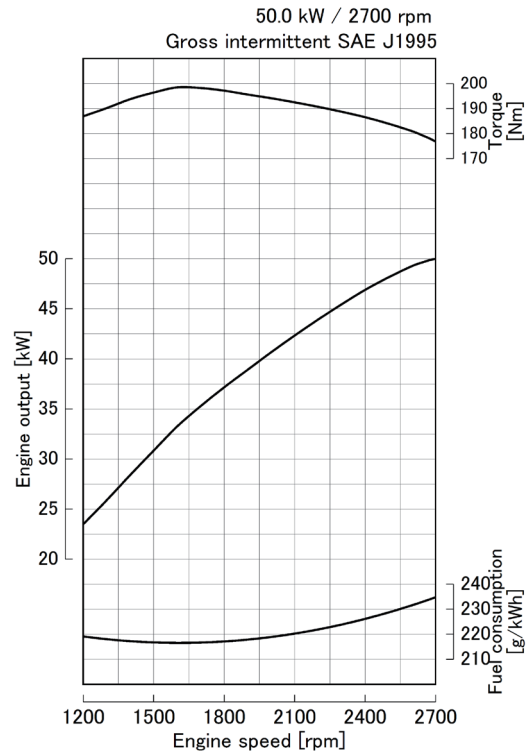

Features and Benefits

Emissions Compliance

Meeting rigid emissions regulations can be a challenge for any company. V2403-CR-T-E5 engines have been designed to comply with stringent regulations: EPA/CARB Tier4 + EU Stage V.

Advanced DPF Technology

Diesel Particulate Filters (DPF) are essential to meeting EU Stage V emission regulations. With many years of experience in DPF engines, Kubota has developed a DPF technology that enables automatic regeneration even at a low rpms, giving your product a competitive edge.

The technology has also made long service intervals possible, helping to minimize downtime and maintenance worries.

Clean and Quiet Power

A common rail system has made it possible to optimize combustion and create a more durable and quieter engine with higher fuel efficiency. By meticulously screening and controlling the exhaust gas aftertreatment components, we are able to offer a clean and high-performance engine.

Great Flexibility

Providing global solutions with great flexibility is a must when working with customers in different countries who have different engine needs. Kubota 03 Series engines have evolved every step of the way in meeting the requirements of each EPA Tier. As such, we are able to provide our customers worldwide with engines certified for the appropriate emissions regulations.

In addition, we have designed aftertreatment units with minimum impact for easy installation. The Kubota 03 Series is the ideal solution for your company's global marketing strategy.

For Earth, For Life
Kubota

V2403-CR-T-E5

Engine Specifications

Engine model		V2403-CR-T-E5
Emission regulation		EPA/CARB Tier4 + EU Stage V
Type		Vertical, water cooled 4-cycle diesel engine
Cylinders		4
Bore and stroke	mm (in)	87.0 x 102.4 (3.43 x 4.031)
Displacement	L (cu.in)	2.434 (148.5)
Aspiration		Turbocharged
Aftertreatment		DOC + DPF
Rated output / speed *1	kW (HP) / rpm	50.0 (67.1) / 2700
Maximum torque / speed *1	Nm (lb-ft) / rpm	198.5 (146.4) / 1600
Combustion system		Direct Injection
Fuel system		Common rail system
Length x Width x Height *2 (without aftertreatment unit)	mm (in)	646 x 540 x 735 (25.4 x 21.3 x 28.9)
Length x Width x Height *3 (with aftertreatment unit)	mm (in)	842 x 540 x 735 (33.1 x 21.3 x 28.9)
Dry weight *3	kg (lbs)	233 (514)

Specifications are subject to change without prior notice.
Dimensions and dry weight are according to Kubota's standard specification.
Dimensions and weight depend on completed specifications.

*1: Gross intermittent SAE J1995

*2: Exclude cooling fan and exclude aftertreatment unit

*3: Exclude cooling fan and include aftertreatment unit

Dimensions

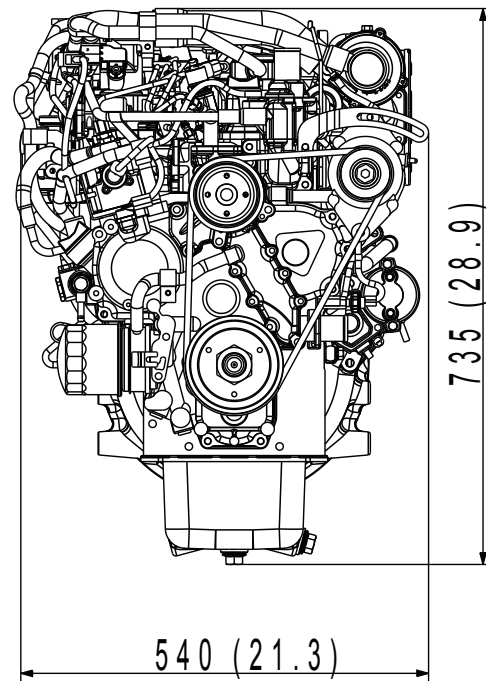
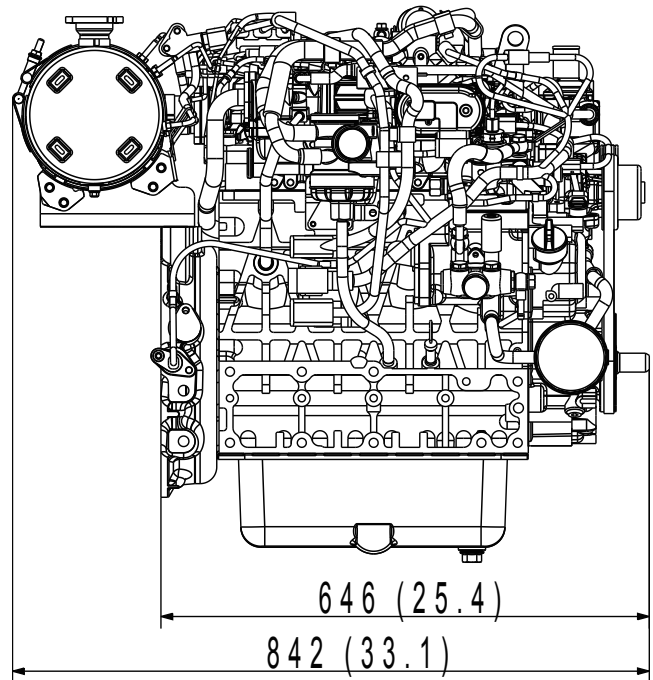

Kubota Corporation

2-47, Shikitsu Higashi 1-chome Naniwa-ku, Osaka, 556-8601 Japan

<https://global.engine.kubota.co.jp/en/>

ASP-V2403-CR-T-E51902-N0-I-178040